

IP POWER 9258 / 9258 Ping USER MANUAL



USER MANUAL



IP POWER 9258S / 9258T / 9258Ping
Firmware Version: V1.50
Oct. 1, 2008

Warning:

Any changes to this equipment without permission may cause damages to your equipment! This equipment has been proved by CE & FCC to can be prevented from the influence of harmful electronic jamming in normal business use condition.

IMPORTANT NOTICE

1. We have no responsibility for the possible damage caused by improper usage or abnormal working environment.
2. Do not use IP POWER in strong shaking condition.
3. Please contact the dealer If IP POWER works improperly.

Copyright © 2005 All rights reserved. No part of this publication may be reproduced, stored in a retrieval system, or transmitted in any form or by any means, electronic, mechanical, photocopying, recording or otherwise, without the prior written consent of us

All other products mentioned in this document are trademarks of their respective manufactures.

We are exempt from notify any change of our products.

Table of Content

1. INTRODUCTION	4
FEATURES	
9258 FUNCTION DESCRIBE	
2.SPECIFICATION	5
PACKAGE CONTENTS	
MINIMUM SYSTEM REQUIREMENTS	
3.INTERFACE DESCRIPTION	6
4.HARDWARE & SOFTWARE INSTALLATION	7
HARDWARE INSTALLATION	
SOFTWARE INSTALLATION.....	
5. INITIAL SETTING	8
INITIAL SETTING THROUGH ETHERNET	
SETTING OF SOFTWARE SHUT DOWN CONTROLLED PC/ SERVER.....	
6. HARDWARE CONTROL & SETTING	13
7. CONTROL AND SETTING THROUTH THE INTERNET EXPLORE	14
LOGIN.....	
CONTROL THE POWER SUPPLY OF OUTLETS.....	
POWER SUPPLY STATE QUERY.....	
SYSTEM SETTING	
SETTING THE PASSWORD.....	
SETTING THE IP ADDRESS.....	
EMAIL SETTINGS.....	
SETTING THE TIME SCHEDULE.....	
SETUP UP OWN OUTLET DEFAULT STATUS	
. Internal Clock Settings & Network Time Protocol (NTP).....	
. WAKE ON LAN.....	
. FIRMWARE UPDATE:	
8. DDNS SETTING	24
9. CHECK STATUS THROUGH SNMP	25
10. CONTROL AND SETTINGS THROUGH HTTP ORDER	26
ORDER FORMAT.....	
11. FAQ	28
12. Webpage Customization	28

1. Introduction

IP POWER 9258 is a web controller which can be easily used in the industry field. With the remote network control technology, user can control or query the power supply of equipment. User can do this in any computer connected to the internet or local area network, there is no special program needed, also there is no need to open the external case of the computer. Try to imagine that while traveling in a foreign country, you can control the power supply of your electric equipments, such as a computer, a server, a router, an entrance guard or security / surveillance system directly or use a time schedule comes with the IP POWER 9258. You can remotely control the power switch with any computer connected to the network, which is not only convenient, but it also big saving on the manpower and time.

Feature

1. Built in web server, can be used through the Ethernet or Internet network.
2. Support multiple browser, such as Internet Explore, Netscape, you can operate the switch and check the state without any special program.
3. **Control 4set AC: outlet equipment at the same time.**
* **9258T - Outlet NEMA5-15P / 9258S - Outlet IEC320-C13.**
4. Supported HTTP, **DDNS** , SMTP, SNMP, INTERNET- fixed IP, DHCP, LAN - virtual IP
5. Security passwords identify. Easily installed and can be updated online.
6. Supported RS232 port communication, indicate all kinds of real time state of 9258.
7. Separated LED indicates the state of each switch.
8. Develop tool (**SNMP**) is provided. It can be modified to meet the user's special need.
9. Safely designed for high voltage resistance and protection for leakage of electrical currency, using nonflammable material
10. **Network Server reboot** -- can remote control to reboot the power on for the PC or Server at remote site ,
11. **Timer Schedule** -- can pre-set the time schedule to turn power on / off thru Internet / Ethernet.
12. **Support NTP (Network Time Protocol)** - synchronize the time of 9258 to the Internet web address time.
13. **Setup up own outlet default:** when regain power it store each outlet to those status setting.
14. **Arrange own webpage design** : Change the user-defined graphics and hyperlinks to customize the web pages by webpage SDK
15. Provide **SDK (VB & VC)** for own Software develop and application.
16. **Safety shut down controlled PC/ Server (WINDOWS OS)**
17. **Local Hardware each outlet ON /OFF**

Specification

- * Maximum rated voltage for each 4 outlet: 250V AC, 24V DC
- * Maximum rated currency for each 4 outlet: **(Total) 15A AC/DC,**
- * Maximum rated currency: **(Individual outlet) 6A AC/DC**
- * Action delay: Max 10ms
- * Working temperature: 0~ 70°C

2. Specification

Package contents

* 9258S - For EU / AU / UK



* 9258T – For USA / TW / JP



Option; RJ45 (Cat5) net wire

Option : Power Cable (Choose one)

Minimum System Requirements

- Intel Pentium III 300MHz or above/compatible AMD CPU
- WINDOWS operating system (IE5.0+SPI) & LINUX
- Minimum 64MB RAM
- VGA Card: supported direct draw
- Network card with RJ45 port & Ethernet HUB or Switcher
- Internet network (Ethernet, ADSL or other ways, depends on whether you need far end control ability or not)

NOTICES:

1. IP Power 9258S: for **220-250V**, please use **power (IN) wire at 10A current**.
Max output current: (total) 10A. Max (individual) 6A.
2. IP Power 9258T: for **100-120V**, please use **power (IN) wire at 15A current**.
Max output current: (total) 15A. Max (individual) 6A.

3. Interface Description

IP Power 9258

Front interface shown below:



From left to the right

1. RESET: self-protect AC reset button. IP Power 9258 can cut off the power supply of outlets automatically if there is a shortcut or current overload. After user having solved the problem, push the **reset** button, the AC power supply will become normal.

2. LED: 4 LED indicator lights. If the LED is on, means the corresponding outlet is power on.

3. RS232 port: provide the power output state and get IP address to re-update if update fails

4. Output: To connect with daughter device - IP Power 9258 Outlet



5. Circle sign and On & Off: Hardware power ON /OFF setup. Please do o refer page 11 for proper operation.

6. RJ45 Ethernet port: link to the net wire.

Rear interface shown below:

9258S:



9258T:



Port description (from left to the right)

1. 90-240VAC power input port

2. Power switch: the power switch ON /OFF of IP Power 9258.

3. OUT 1- 4: 4 individually switched AC outlets

4. Hardware & Software installation

Before you start to use IP Power 9258, please follow the steps below

- Check the package to make sure the contents is complete.
- Prepare one Ethernet HUB or Router
- Check the voltage of the power supply to make sure it is AC 110-240 volt
- Please confirm the specification of your power cable.
 - IP Power 9258S: for **220-250V**, please use the **10A** power cable.
 - IP Power 9258T: for **100-120V**, please use the **15A** power cable.

Hardware installation

- a) Connect the 9258 to HUB through network wire.
- b) Connect the HUB or Router to the internet (either through DSL or Cable modem).
- c) Connect the power adapter to the 9258.
- d) Connect the power adapters of under control electric equipment to corresponding out port of 9258.

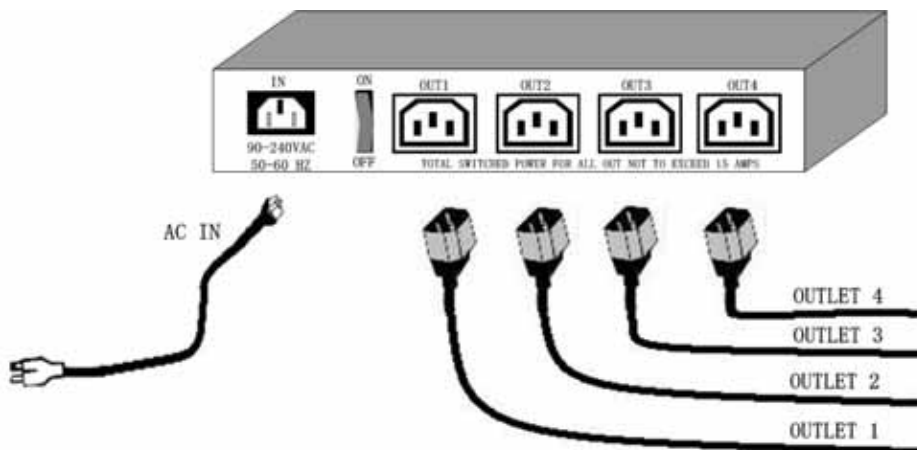

Turn on your computer and the power adapter of IP Power 9258

*

For 220-250V, please use power wire can support 10A current.

Max. Output current: (total) 10A, (individual) 6A.

Max. Output current: (total) 15A, (individual) 6A

Software installation

Please follow the steps below to install the software.

6. Insert the Installation CD in the package and windows will auto-run. If not please browse for the Autorun.html file in CD.
7. Click **IPedit** in the downloads section of the installation CD



8. Save IPEdit to your desktop or any other place of your choosing
9. After you have saved it onto your desktop it is ready to be used.

5. Initial Settings

Initial setting through the Ethernet

Open "IPEdit.exe". Make sure that the IP Power 9258 is properly turned on and there is an ethernet connection connected by a RJ45 cable.



In the local devices section of IPEdit all products under the same subnet network will appear. Please refer to (Figure 1.1) below:

(Figure 1.1 IPEdit)

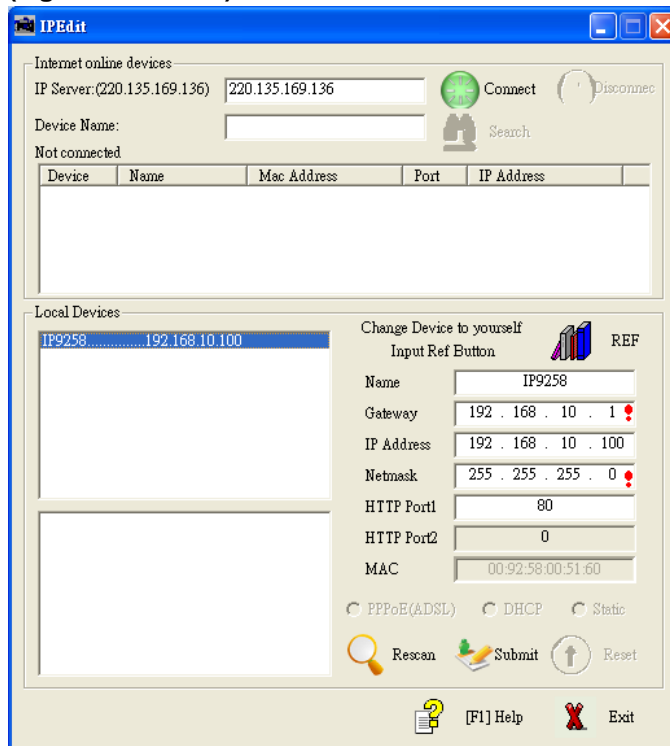

(Figure 1.2 IPEdit)

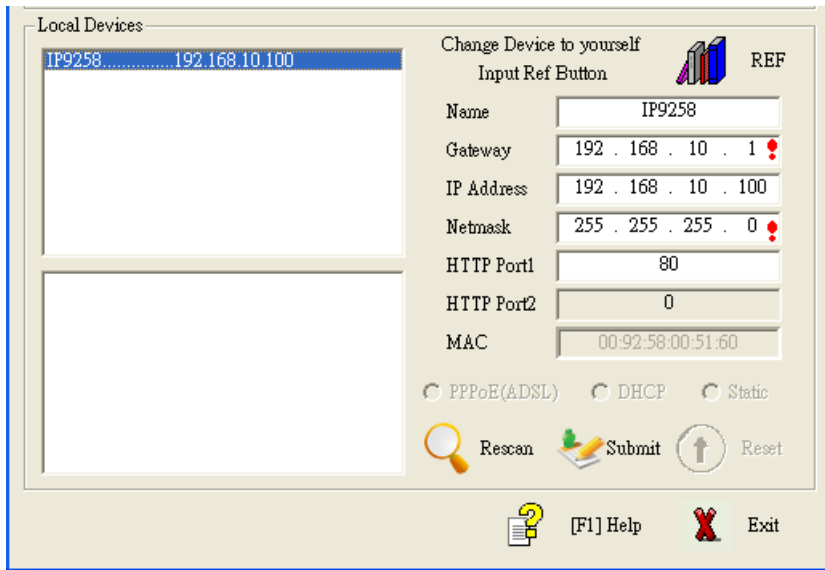

IPEDIT will search and display all IP Products 9XXX series under the same local Ethernet. The default name for the IP Power 9258 is “IP9258” Please refer to (Fig. 1.2 above).

1. Double click and highlight your IP Power 9258 device. The default device name and IP/Network settings will all be displayed on the right hand side of IPEdit.

Make sure that the IP Address of your 9258 is setup on the same subnet network as your PC’s (Subnet mask, Gateway)

*  Represents that your 9258 does not match the gateway of your router.

(E.g. If the Default Gateway of your computer is 192.168.1.1 The IP Address of your 9258 will need to be set up to 192.168.1.XXX.)

2a. **Automatically Detect Network settings** (Please go to 2b. for steps on how to manually enter network settings)

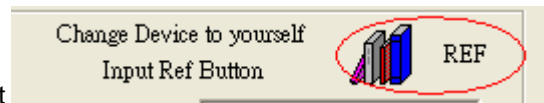

a.) Click on the REF button to the right of IPEdit

b.) Please wait a few seconds while IPEdit detects your network settings. Then click the Apply button to apply the new network settings

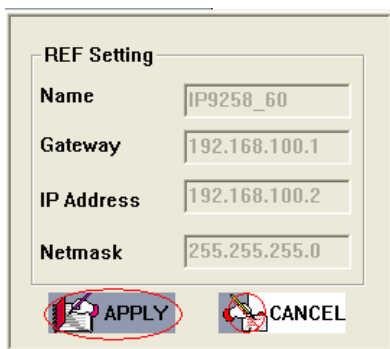

2b. Manually enter network settings In Ipedit:

a.) You can manually enter the networks settings for the following:

The name: (please use numbers or letter)

Gateway IP: (The default gateways IP can be found using

IP Address: (please set in the same subnet as your PC) in the text windows.

b.) Then click **Submit** after the settings have been selected. Wait about 20 seconds for the new settings to be updated.

c.) Click **Rescan**, and the new device settings will display in text window.

Note:

1.) Make sure the RJ45 network cable is connected and the 9258 is powered on.

2.) * The default IP address of the 9258 is **192.168.10.100**. If you cannot get into the webpage of the 9258, please make sure to set subnet of the IP Power 9258 to match with your PC Subnet Mask.

To obtain the IP information manually:

In Windows Go to:

a.) Start → Run → type in "cmd" → Hit enter and the MS –DOS window will open,

b.) Now type in "ipconfig"

```

C:\WINDOWS\system32\cmd.exe
Microsoft Windows XP [版本 5.1.2600]
(C) Copyright 1985-2001 Microsoft Corp.

C:\Documents and Settings\Chiu>ipconfig

Windows IP Configuration

Ethernet adapter 區域連線:

    Connection-specific DNS Suffix . : 
    IP Address. . . . . : 192.168.100.31
    Subnet Mask . . . . . : 255.255.255.0
    Default Gateway . . . . . : 192.168.100.254

C:\Documents and Settings\Chiu>

```

The last set of numbers of the IP address can be any number between 1~254, but cannot be same as your PC, hub, router or any device in the network. If using in any PC, just use HUB and type the 192.168.0.100 in Browser or use "IPDdit.exe " then you can get in the web page.

* Same **SUBNET**: The first 3 sections of IP address is same - XXX.XXX.XXX.abc. The part of XXX must be the same.

(E.g. If IP address is **192.168.1.100** , then another IP address **192.168.1.123** then these IP Addresses are in same subnet.)

5 .The default username and password of IP Power 9258 are:

Username: admin
Password: 12345678

Setting of software shut down controlled PC/ Server

9258 can be used to safely turn off the PC/Server through Network. With this feature you can remotely shutdown any PC/ Server which that is connected to the IP Power 9258 through normal Windows shut down procedure. Before operating the software shutdown function it is essential to install our software:

1. Please install program “IP9258service.exe “into the PC that will be controlled.
2. Documents created in programs like Microsoft office will not be automatically saved. The 9258 will still shutdown the controlled PC/server without saving the file.
3. You will need to reserve enough time for controlled PC/Server to shutdown after receiving a command from the 9258. Please set the delay time at 30 or 60 second in 9258 configuration webpage (setup→ **delay switch**).

Http Command Verification	<input checked="" type="radio"/> Cookie+Base64 <input type="radio"/> Cookie
DelaySwitch	60 Sec ▼

4. The controlled PC/Server must be in the same ETHERNET and the same SUBNET as the 9258.

Installing and Setup of the “IP9258service.exe”:

1. Insert the CD that came with the device into the PC that you want to be able to turn off.



2. Click on the icon



3. On the left hand side click on the icon.
4. Go to the 9258 Series section and click on the Link that says Shutdown Program

9258 Series (9258,9258-1U,9258-SX) SDK

	SDK (Visual C++ 6.0)	Application	SDK Manual(English)
	SDK (Visual Basic 6.0)	Application	SDK Manual(English)
9258Shutdown Program	Shutdown Program		
9258WebpageSDK	Webpage SDK	SDK manual (English)	SDK manual (Chinese)
9258 Firmware	9258.bin (English)		

5. Save to your desktop and double click “ IP9258config.exe” , to install the program:

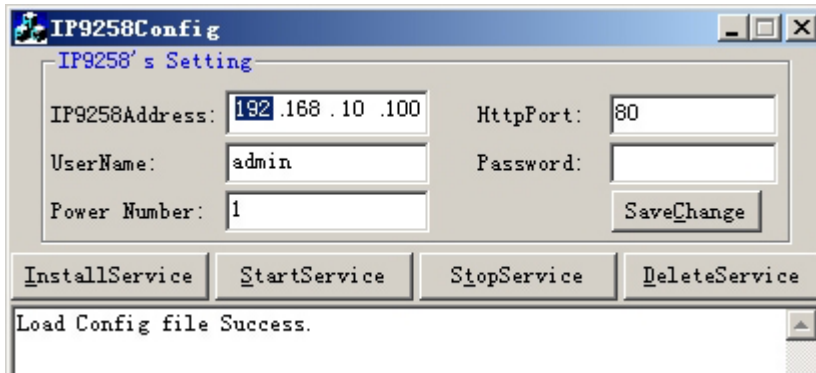

6. Please fill correct information in each section :

- * **IP9258 Address:** Please type in the IP address of the 9258.
- * **Http Port:** Fill the port of 9258, default value is 80, if amend the port in 9258 please correct.
- * **UserName:** admin
- * **Password:** 12345678 (password can amend in web page)
- * **Power Number:** Please enter the power number in the 9258 that you want to control (If many PC/Server use same power extended line, the extended line connect to channel 1 of 9258 and if all the PC / Server set as channel 1 and same IP address in IP9258service.exe , then all the PC/Server will be controlled at same time).

- a.) Click on "**Save Change**".
 - b.) Then Click "**InstallService**".
 - c.) Then "**StartService**" then please shutdown the PC/Server.
- After the PC has been restarted, the function will be in effect.

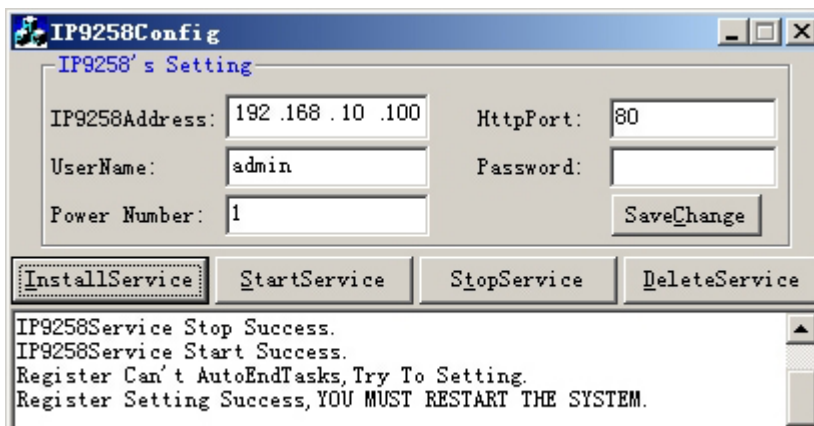

6. Hardware Control & Settings

* This function teaches you how to use the hardware control the power on/off of the devices

NOTE:

This function is solely used for manually selecting which ports you need to be on or off. It was designed so that you can still have the ability to turn on or off certain ports in the case you do not have Ethernet connection.

Before using the H/W control function, please UNPLUG all the 4 connection or ports connected to the 9258.

Control panel as follow:



To activate Hardware control: Hold the On/Off Button for 5 seconds until you hear one beep which activates the H/W Control function. The LED lights in the front panel should continuously flash and you can hear the relay clicking when activated.

To deactivate Hardware control: Hold the On/Off Button for 5 seconds until you hear one beep which deactivates the H/W Control function.

1. **Left Button** (Circle button): Select power outlet 1 ~4.
2. **Right Button** (ON/ OFF): Turn ON/OFF each outlet.

HARD RESET

To Reset the Device Back to Manufacturer Default:

- a) First Turn off the device wait for 5 seconds, then power on the 9258.
- b) **Press and hold** the two buttons on the front panel of the 9258 at the same time.
- c) Keep holding until you here 2 short “beep” sounds and one long “beep” sound.
- d) Once the device has been reset refer to the following settings below.



Factory default settings:

User Name: admin.

Password: 12345678

Device IP Address: 192.168.10.100.

Default Gateway: 192.168.10.1

7. Control and settings through the Internet Explorer)

IP9258 Login

Please enter user name and password.

User Name

Password

To login to the IP Power 9258 device through Internet Explorer, type in the IP Address of your device into the address field of IE.

This will take you to the IP 9258 Login page.

Default User Name: admin
Default Password: 12345678

Once you have typed in the correct login information click okay and you can start making changes to the web server.

Control the power supply of outlets

Once you are in Web Control page of the 9258:

Click the **SET POWER** Link on the left side of the page. From here you can control the IO or Power setting page (see figure below):



IP9258

Power
[SetPower](#)

System
[Setup](#)
[DDNS](#)
[E-mail](#)
[Change Password](#)
[Power Schedule](#)
[Network Wakeup](#)

[Firmware Update](#)

Internal Time:
[Change Time](#)

2008-04-23 07:55:10

I/O Control

Power	Control	Timer
Power1	<input checked="" type="radio"/> On <input type="radio"/> Off	0 <input type="text"/> Sec <input type="radio"/> On <input checked="" type="radio"/> Off
Power2	<input checked="" type="radio"/> On <input type="radio"/> Off	0 <input type="text"/> Sec <input type="radio"/> On <input checked="" type="radio"/> Off
Power3	<input checked="" type="radio"/> On <input type="radio"/> Off	0 <input type="text"/> Sec <input type="radio"/> On <input checked="" type="radio"/> Off
Power4	<input checked="" type="radio"/> On <input type="radio"/> Off	0 <input type="text"/> Sec <input type="radio"/> On <input checked="" type="radio"/> Off
<input type="button" value="Apply"/>		

With this page the user can control the Power On/Off of the 4 separate outlets. It also includes a timer feature that allows you to delay in seconds when you want the power to activate after you click on apply.

Power: Labels the name of the device or port that you want to control

Control: Turns on or off the device connected

Timer: Allows the user to delay in seconds the action of the device after the Apply button has been pressed.

Power Supply State Query

Click the “**Set Power**” button on the left column, and the page will be refreshed. The state of each electric outlet will also be displayed in column control.

System Settings of 9258

System

[Setup](#)

[DDNS](#)

[E-mail](#)

[Change Password](#)

[Power Schedule](#)

[Network Wakeup](#)

[IPsrv Conf](#)

[Firmware Update](#)

Internal Time:

[Change Time](#)

2008-04-24 08:48:33

1.) Setup – System Configuration

System configuration page:

Click on the **Setup link** located on the left hand column. In this page the user will be able to manually enter the **IP Address, Subnet Mask, Default Gateway, DNS:, DHCP Client, Beper, Http Command Verification, Delay Switch, and Release Version**

System Configuration

Please restart for any changes to take effect.									
IP Address:	192	.	168	.	100	.	16	.	80
Subnet Mask:	255	.	255	.	255	.	0		
Default Gateway:	192	.	168	.	100	.	1		
DNS:	202	.	103	.	24	.	68		
DHCP Client	<input type="radio"/> Enable <input checked="" type="radio"/> Disable								
BEEPER	<input checked="" type="radio"/> Enable <input type="radio"/> Disable								
Http Command Verification	<input checked="" type="radio"/> Cookie+Base64 <input type="radio"/> Cookie								
DelaySwitch	0.Sec <input type="button" value="v"/>								
Device Name:	IP9258								
Release Version:	V1.50-1 2008/03/28								
					<input type="button" value="Submit"/> <input type="button" value="Cancel"/>				

Http Command Verification: Setup the control possibility from HTTP command or SDK (VB & VC)

1. Select **Cookie+Base64**: To enable Http command & SDK control
2. Select **Cookie**: To disable Http command & SDK control

2-1 IP address Settings: Ethernet (LAN) and Internet (WAN)

2-1-1 Local Area Network (LAN):

In LAN, you can set a fixed IP address or gain it from a DHCP server automatically. We recommend you use a fixed IP address so you can access the 9258 through the internet.

Now type the new IP address in the address field of IE, you can visit the 9258. You also can use the ipedit.exe to find the IP Power 9258 and modify its IP address.

2-1-2 Work on Internet (WAN):

User can set the IP provided by your ISP. If the IP Power 9258 has a public IP address, you can control it through the Internet. IP Sensor 9258 supports fixed IP, DHCP.

- * IP Address: please type in the IP address provided by your ISP. If IP Power 9258 is working with a Router, please refer to the network settings of the Router.
- * Subnet Mask: please type in the Subnet Mask provided by your ISP. If IP Power 9258 is working with a Router, please refer to the network settings of the Router.
- * Default gateway: please type in the Default Gateway provided by your ISP. If IP Power 9258 is working with a Router, please refer to the network settings of the Router.
- * DNS Server: please fill in the IP address of DNS server. If you are in Taiwan, you can set it to 168.95.1.1.
- * DHCP Clients: Enable— activate DHCP service. DHCP will assign IP address for each PC.
Disable – shut down the DHCP service. You can set the IP address by yourself.
- * Beeper: Enable – activate the beeper. Disable – turn off the beeper.
If you control the 9258 through the web page, the beeper will beep once when the operation works.

NOTICE:

1) **IP address format:** XXX.XXX.XXX.XXX:YYYY YYYY means the port number, (I.E 192.168.1.100:2345)

Port ranges from: 1 to 32767

2) **Subnet Mask:** Ranges from 0 to 254 (xxx.xxx.xxx.0 ~ xxx.xxx.xxx.254)

3) If **DHCP is disabled**, then the user must set the **TCP Port** and **default Gateway** .If **DHCP is enabled**, then the TCP port will be preset to 80(xxx.xxx.xxx.xxx:80) and the default gateway will be set by the DHCP server.

2.) DDNS Settings

Please refer to page 23 for more details

3. EMAIL SETTINGS:

When you finished the e-mail settings, you can set to let IP Power 9258 send its IP address automatically.

Setup Email

MailServer:	<input type="text" value="smtp.sample.com"/>
MailServerPort:	<input type="text" value="25"/>
Pop3Server:	<input type="text" value="pop3.sample.com"/>
UserName:	<input type="text" value="sample@sample.com"/>
Password:	<input type="password" value="●●●●●●"/>
Sender:	<input type="text" value="sample@sample.com"/>
Receiver1:	<input type="text" value="receiver1@sample.com"/>
Receiver2:	<input type="text" value="receiver2@sample.com"/>
Receiver3:	<input type="text" value="receiver2@sample.com"/>
Subject:	<input type="text" value="This is a sample email"/>
MailBody:	<input type="text" value="This is where you type the body of the email"/>
<input type="button" value="Save"/> <input type="button" value="Send"/>	

For example:

- * **Mail Server:** smtp.sample.com
- * **Port:** 25
- * **Pop3Server:** pop3.sample.com
- * **Password:** *****
- * **Sender:** Sample@sample.com
- * **Receiver 1:** receiver1@sample.com
- * **Receiver 2:** receiver2@sample.com
- * **Receiver 3:** receiver3@sample.com

* **Subject:** This is the subject line

* **MailBody:** This is the body of the email

- 1.) **Mail Server:** Outgoing Mail Server
Please make sure the server is an available mail server.
- 2.) **Pop3Server:** Incoming Mail Server. IP address (in Internet WAN) from your ISP for sending Internet IP address by E-mail when 9258 in Internet.
To receive IP address in WAN , please fill your ISP e-mail receive server.
In this part, please also set the DNS of your ISP in system configuration.
- 3.) **Password:** the password of this mailbox is **no longer than 8 characters**.
- 4.) **Sender:** please fill in the name of sender. The Mail Server must support SMTP and these fields must be filled in correctly.
- 5.) **Receiver:** no longer than 50 English letters. Please use blank space to separate two receiver's e-mail address. After you have finished this setting, you will receive the email to inform you the IP address of the IP Power 9258 every time you enter the webpage.
- 6) **Subject:** the subject of the mail to be no more than 50 English letters.
- 7) **Mail Body:** please type the content of the mail here, it cannot be left empty.

After you have finished all of the above settings, click "**SAVE**" and your settings will be saved.

4.) Setting the password for IP Power 9258:

Click the "**Change password**" button on the left to enter the password change page.

User can change it into any password (not longer than 8 bit), then click **apply** button to save the change. To change the password you will need to type in the Old Password first, then enter the new password and finally confirm the new password.

The screenshot shows a web form titled "Change Password". It has three text input fields stacked vertically. The first is labeled "Old Password:", the second "New Password:", and the third "Confirm New Password:". Below the third field is a button labeled "Submit".

Note : **If forget the password** , Use username " **super user** " when log in webpage and then click "OK " turn power off for few second and then turn ON power . 9258 will to set back to default password. (There is space between super and user.)

4. Control the IP Power 9258 through Power Schedule:

With the power schedule the user can use this section to schedule daily events to control the devices attached to the 9258

Power Schedule

Power	Date	Time	PARAMETER	Power ON/OFF
Power1A	2000 - 00 - 00	00 : 00 : 00	Disable	<input type="radio"/> ON <input checked="" type="radio"/> OFF
Power1B	2000 - 00 - 00	00 : 00 : 00	Disable	<input type="radio"/> ON <input checked="" type="radio"/> OFF
Power2A	2000 - 00 - 00	00 : 00 : 00	Disable	<input type="radio"/> ON <input checked="" type="radio"/> OFF
Power2B	2000 - 00 - 00	00 : 00 : 00	Disable	<input type="radio"/> ON <input checked="" type="radio"/> OFF
Power3A	2000 - 00 - 00	00 : 00 : 00	Disable	<input type="radio"/> ON <input checked="" type="radio"/> OFF
Power3B	2000 - 00 - 00	00 : 00 : 00	Disable	<input type="radio"/> ON <input checked="" type="radio"/> OFF
Power4A	2000 - 00 - 00	00 : 00 : 00	Disable	<input type="radio"/> ON <input checked="" type="radio"/> OFF
Power4B	2000 - 00 - 00	00 : 00 : 00	Disable	<input type="radio"/> ON <input checked="" type="radio"/> OFF
System Startup Power Default Value:				
Power1		Power2	Power3	Power4
<input type="radio"/> ON <input checked="" type="radio"/> OFF		<input type="radio"/> ON <input checked="" type="radio"/> OFF	<input type="radio"/> ON <input checked="" type="radio"/> OFF	<input type="radio"/> ON <input checked="" type="radio"/> OFF
<input type="button" value="Submit"/>				

Support parameter of operate schedule:

- Disable
- Just Once
- Every day
- Work Day: From Monday to Friday.
- Weekend: Saturdays and Sundays

Setup up own outlet default status:

When power, each outlet will set as appointed default status.

System Startup Power Default Value:				
Power1	Power2	Power3	Power4	
<input type="radio"/> ON <input checked="" type="radio"/> OFF	<input type="radio"/> ON <input checked="" type="radio"/> OFF	<input type="radio"/> ON <input checked="" type="radio"/> OFF	<input type="radio"/> ON <input checked="" type="radio"/> OFF	
<input type="button" value="Submit"/>				

5. Wake on LAN (WOL):

Remote Wake up PC by MAC address in Ethernet (LAN)
 Use Network port (RJ45), you can wake PC on WAN by PC `s MAC address.

Wake on LAN (WOL) premise:

- (1) First the main board needs to have Wake on LAN support. There must be a port to connect to your network card. If the motherboard supports WOL , will need to enable this function in the BIOS setting.
- (2) Your network card must also support "WOL", remember to connect your connect cable to Main board or the network card cannot send the "power on" message to your motherboard.

After both the motherboard and network card have been setup, you can use WOL function by following the steps below:

Step 1: Log in 9258 web page and go to "Network Wakeup"

Step 2: Type in your MAC address then press “send” – the PC will be power ON.

Network Wake Up Setup

MAC: 0050BA0053

Save Send

6. Internal Clock Settings & Network Time Protocol (NTP):

* User can enter the internal clock settings: year, month, day, hour, minutes and second.

* NTP function: customer can synchronize the time of 9258 to the Internet web address time.

7. IP Service

IPSrv Config

IPSrv ON/OFF: ON

IPSrv ServerAdr: 220 . 135 . 169 . 136

Save Cancel

IP Server gives the user the ability to easily search for the name of the device other than searching for a long IP number. This flexibility allows the user to easily just remember the name of their device so they can access it with ease.

To Enable IP Server:

Go to **IPSrv Conf** on the Left hand side of the Webpage and then make sure you have **IPSrv On/Off** on **On**. The default IP server IP Address is **220.135.169.136** and provided.

The user can also setup his/her own IP Server system and use their own address as well.

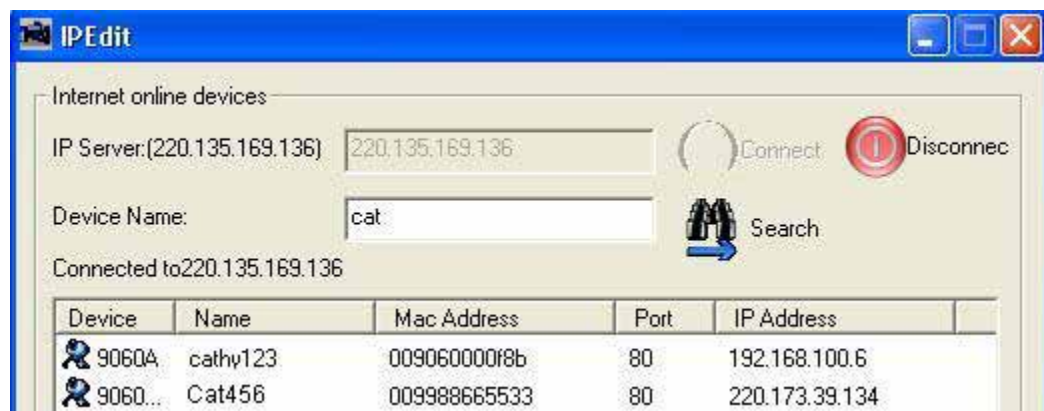

By setting the server address in IP server of advanced setup page, the user can easily search for his/her IP Power 9258-1U on internet just by searching for the name of the device. The **default IP address of IP server is 220.135.169.136**.

Step1: Click the green “connect” button

Step2: In the device name section: Type in the name of your device (Min of 3 letters)

8. Ping Function: *Only Available on the 9258 Ping model

The Ping Function (Only on the 9258 Ping Model) was created to automatically act as a watch dog for the devices attached. If the devices attached to the 9258 does not respond appropriately, the 9258 will restart the device automatically.

Settings

[Ping Setting](#)

Relay Setting										
Relay	Enable	Ping IP				NoEcho Count	BeforeAction Delay (Seconds)	AfterAction Delay (Seconds)	AfterAction	Action
Power1	DISABLE	192	168	10	1	1	1	2	Continue	Reset
Power2	DISABLE	192	168	101	1	5	2	5	Continue	Reset
Power3	DISABLE	192	168	10	185	1	3	6	Continue	Reset
Power4	DISABLE	192	168	45	98	10	4	8	Continue	Reset
Global Setting										
Ping Interval:	10		Seconds							
Ping EchoWait::	100		Millisecond							
Submit										

Enable Settings to Start Pinging device

[Ping Setting](#)

Relay Setting										
Relay	Enable	Ping IP				NoEcho Count	BeforeAction Delay (Seconds)	AfterAction Delay (Seconds)	AfterAction	Action
Power1	ENABLE	192	168	10	1	5	1	2	Continue	Reset
Power2	DISABLE	192	168	101	1	5	2	5	Continue	Reset
Power3	DISABLE	192	168	10	185	1	3	6	Continue	Reset
Power4	DISABLE	192	168	45	98	10	4	8	Continue	Reset
Global Setting										
Ping Interval:	10		Seconds							
Ping EchoWait::	100		Millisecond							
Submit										

Enable: This setting turns on or off the ping function

Ping IP: IP Address of the device that you are trying to ping

No Echo Count: The number of Unsuccessful Ping responses.

Before Action Delay: After No Echo Counts have reached its number, this is the number of seconds before an action occurs.

After Action Delay: After the action occurs, this is the number of seconds before the after action occurs. *Note: This is also known as the PC or Device Startup Time. Set this to number to 90 or above to prevent infinite looping of the device.

After Action: This is the command to continue pinging or to stopping pinging

Action: From here you can Reset, On, Off on the device

Ping Interval: The number of seconds between each unsuccessful Ping

Ping EchoWait: The number of Milliseconds that the 9258 Ping will wait for a response from connected device

Note:

1. When the Ping function is enabled, it is possible that user may not receive the e-mail sent from 9258 to notify the user, due to the bandwidth limit of the IP Address.
2. Do not use the relay delay switch function when the Ping function is enabled. In the Setup page, the delay switch is not relative with Ping function.

9. Firmware update:

If no firmware to update please do not go to this page.

When there a new firmware to update, the user will get additional functions that is created for the IP Power 9258. Click the firmware update on the right side of the page; and wait for a new window to pop up.

Step1: Click the “firmware update” you will see follow webpage:



Note: **Do not click “update” if there is no firmware file to update.**

Step2: Click update button, the following window will pop up.



Step 3: Click the Brower button to find the corresponding update file (you can download it from our web site or ask it from the dealer), then click Update button to start update firmware. When the update is finished, you must wait one minute before you restart the IP Power 9258.

NOTICE:

- * Before running the online update program, please make sure that the TCP port is set to 80, or the online update may fail.
- * Please check with your reseller /distributor / importer for the update news.
- * If the update fail please refer chapter 10 “Webpage Customization”

Please refer following the NTP server IP address:

- * 131.246.9.116
- * 139.18.25.34
- * 128.176.191.9

Note: To work NTP, please do set up in e-mail and have to receive e-mail from 9258.

Setup DateTime

DateTime:(yyyy-mm-dd HH:MM:SS)						
2008	-	4	-	24	10	: 30 : 51
NTP Server IP Address:						
192	.	43	.	244	.	18 TimeZone:0
<input type="button" value="SAVE"/> <input type="button" value="NTP"/>						

Note:

1. If the Network card is not onboard card, it needs to connect with your Main board by cable. Please refer your network card connection
2. You can get your MAC address in PC , please refer following pictures :
Go to Network sign → Status → Support → Details
Then the value in Physical Address "is the PC` MAC address.

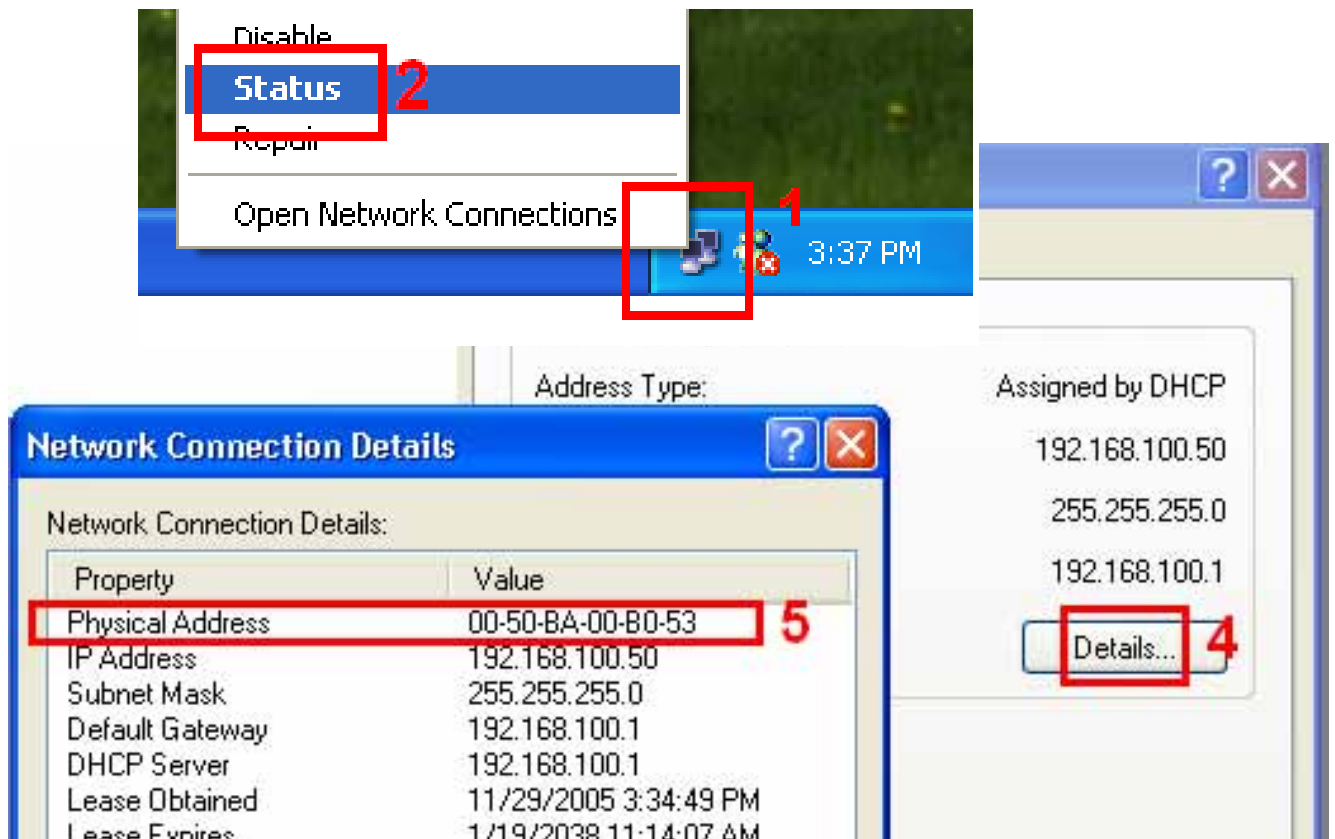

8. DDNS setting

DDNS Setting

2. DDNS Setup

When the user connects to the Internet through ADSL (PPPOE Service), the IP address that you receive from ISP is usually a dynamic IP Address. Therefore when someone wants to visit your device they are usually not able to because the IP Address is dynamic and it will keep changing. By using DDNS this problem is solved.

Below we will explain using the DDNS service provided by www.dyndns.com:

1.) First, apply for a domain name (Ex. yourdomain@dyndns.org) in www.dyndns.com for the 9258.

2.) Set the domain password and select the proper DNS server (for example, dnsdojo.net) for domain name resolve.

1.) Then input the Domain Name Server (host name), user name, password, and, etc in the DDNS webpage of 9258.

2.) After you have set every up correctly every time the 9258 start or user selects submit, the 9258 will send a message package including its current IP address, domain name to www.dyndns.com, then the DNS server you choose will link the domain name of 9258 to its current IP address. That way the visitor can visit the 9258 webpage by inputting the domain name of 9258 (abcdefg.dnsdojo.net) in the address column of the browser.

DDNS SETUP

DDNS SETUP	
DDNS Server IP:	<input type="text" value="123.234.123.234:80"/>
Your Domain:	<input type="text" value="sample.dyndns.info"/>
DDNS UserName:	<input type="text" value="sample"/>
DDNS Password:	<input type="password" value="•••••"/>
Enable DDNS:	<input type="button" value="No"/> ▾
Proxy Enable:	<input type="button" value="Yes"/> ▾
Proxy IP:	<input type="text" value="proxy.sample.net"/>
Proxy Port:	<input type="text" value="80"/>
<input type="button" value="SAVE"/> <input type="button" value="Apply Changes"/>	

DDNS Server IP: Type in the IP Address and port number provided by www.dyndns.com Please refer to the figure above for reference.

Your Domain: Please type in the domain name that you have chosen to use.

DDNS UserName: Enter your DDNS User Name here

DDNS Password: Enter your DDNS password here

Enable DDNS: This setting allows you to enable DDNS or disable. Select True – If you want to enable DDNS and Select False – If you want to disable DDNS

Proxy Enable: If you need to use a proxy Server, Select True – to enable proxy and Select False – to disable proxy.

PROXY IP: If proxy is enabled you will need to enter the Proxy Servers IP Address

PROXY PORT: If proxy is enabled enter the port of your proxy server IP Address here

Note: Once you are done setting up these configuration settings make sure you hit the Save Button and then the Update Now to confirm completion

9. Check 9258 status though SNMP

9258 support SNMP V1 and V2 , user can use snmp program to get the status of each port in 9258.

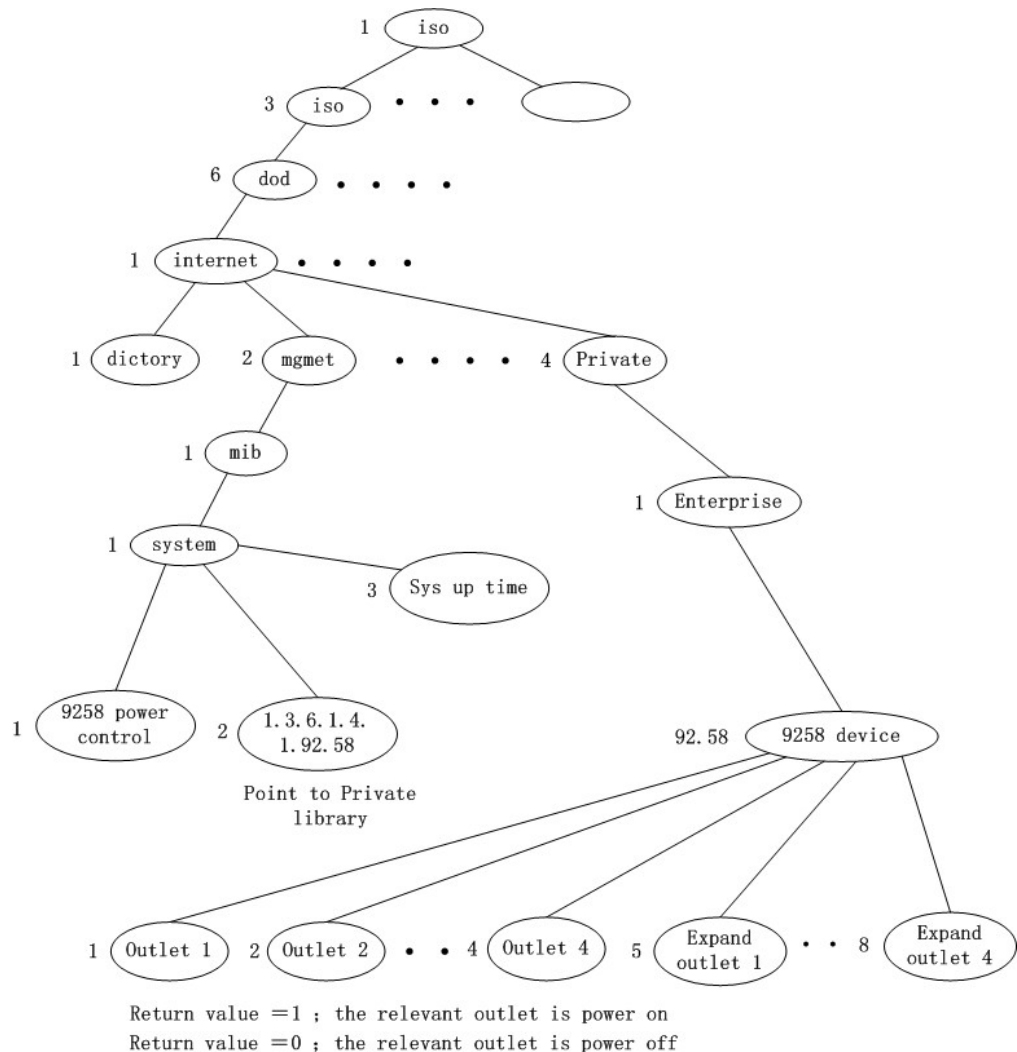

10. Control and Settings Through HTTP Order

User can control the 9258's action directly through the HTTP orders.
The format of the HTTP order is:

http://username:password@XXX.XXX.XXX.XXX/Set.cmd?CMD=Command+para1=*+para2=*+para3=*

Explanations for the command syntax:

Username: 9258's username, default username is **admin**

Password: 9258's password, default password is **12345678**

XXX.XXX.XXX.XXX the IP Address of 9258

CMD=*Power:** the function module of 9258

para1 ~ para3 parameters

Example 1: Control the power supply of 9258 using **SetPower:**

http://admin:12345678@192.168.1.10/Set.cmd?CMD=SetPower+P60=1+P61=1+P62=1+P63=0

This command control IP Power 9258 IP address at **192.168.1.0**, user name is

* Function of 9258:

1. **SetPower:** To control I/O - read parameter as follow

http://admin:12345678@192.168.1.10/Set.cmd?CMD=GetPower

out2 - out4 same as out1

2. **GetPower:** Reads output 1-4 to see if the status of each output

http://admin:12345678@192.168.1.10/Set.cmd?CMD=GetPower

Explanation for the command **SetPower:**

IP address (XXX.XXX.XXX.XXX): 192.168.1.10 (IP Address of the device)

Username: admin (Username of the device)

Password: 12345678 (Password of the device)

When you use this command, 9258 you will get the following message output:

<html>P60=1,P61=1,P62=1,P63=0</html>

* **Schedule Control:** User can use this Http command to have the 9258 perform a specific task at the specified time.

The format of the command is located below:

http://username:password@XXX.XXX.XXX.XXX/Set.cmd?CMD=SetSchedule+Power=+YY=****+MM=**+DD=**+HH=**+MN=**+SS=**+PARAM=****+ONOFF=***

Explanations of each part of the order for the command **SetSchedulePower:**

IP Address (XXX.XXX.XXX.XXX): 192.168.1.10 (IP Address of the device)

Username: admin (Username of the device)
Password: 12345678 (Password of the device)

Control parameter are 1A 1B 2A 2B 3A 3B 4A 4B.
 A means connect power. B means discount power

YY=**+MM=**+DD=**+HH=**+MN=**+SS=* :** time parameter
 YY : year (20YY) , 01 = 2001
 MM : month (0 1-12)
 DD : date (01-31)
 HH : hour (24 hours: 0- 23)
 MN : minute (1-60)
 SS : second (1-60)

PARAM=* : time schedule parameter. Parameter list as follow:

128: Only ONCE
 127: EVERYDAY
 31: MONDAY to FRIDAY
 96: SATURDAY & SUNDAY

ONOFF=*: operate parameter
 0 = open
 1 = close

Example 1 : control power on / off of 9258:

**http://admin:12345678@192.168.1.10/Set.cmd?
 CMD=SetSchedule+Power=1A+YY=2006+MM=02+DD=16+HH=06+MN=02+SS=16+PARA
 M=128+ONOFF=1**

In the command above the IP Power 9258 IP address is 192.168.1.0, user name is **admin** and password is **12345678**. This 9258 will connect power of outlet1 (p60) on 2006/2/16 06:02.

Note :

1. Please use "+" to separate each parameter, you can control the on/off power of each outlet by using this command:

http://admin:12345678@192.168.1.10/ Set.cmd?CMD=SetPower+P60=1

2. Please follow format of the command because it is case sensitive.

11. FAQ

Q1: I forgot the password and can not enter the administration page now, what can I do?

A1: Use username **"super user"** when log in webpage and then click **"OK "** turn power off for few second and then turn on **ON . 9258 will to set back to default password.** (There is space between super and user.)

Q2: Why does the on/off operation can not work immediately?

A2: If you operate the IP Power 9258 in a LAN environment, the operation will work immediately and smoothly. But ff you operate it through the Internet, the response time depends on the situation of the network and the speed of your internet.

Q3: What if the update fails and I cannot find the device in IP Edit anymore?
A3: Refer to page 30 of the manual for instructions on how to reupdate.

12. Webpage Customization

Customer can use our Web page SDK to amend the word and background pictures for your 9258. If not familiar html coding and webpage design, please do not attempt this portion because it may cause problems with your device.

Important Notice:

1. **Make sure that the number of characters for the file name does not exceed the original**
2. **Do not change the structure of webpage – you can only change the pictures and the background.**
3. **The webpage only supports HTML code.**

Step 1: Open the 9258 Webpage SDK file , and choose the webpage that you plan to change.
 For example: web page “ipcontrol” html file



Step 2 : Open and edit webpage “ipcontrol” html file :

I/O Control

Power	Control	Timer
Power1	<input type="radio"/> On <input type="radio"/> Off	[TGLP6] Sec <input type="radio"/> On <input type="radio"/> Off
Power2	<input type="radio"/> On <input type="radio"/> Off	[TGLP6] Sec <input type="radio"/> On <input type="radio"/> Off
Power3	<input type="radio"/> On <input type="radio"/> Off	[TGLP6] Sec <input type="radio"/> On <input type="radio"/> Off
Power4	<input type="radio"/> On <input type="radio"/> Off	[TGLP6] Sec <input type="radio"/> On <input type="radio"/> Off
<input type="button" value="Apply"/>		

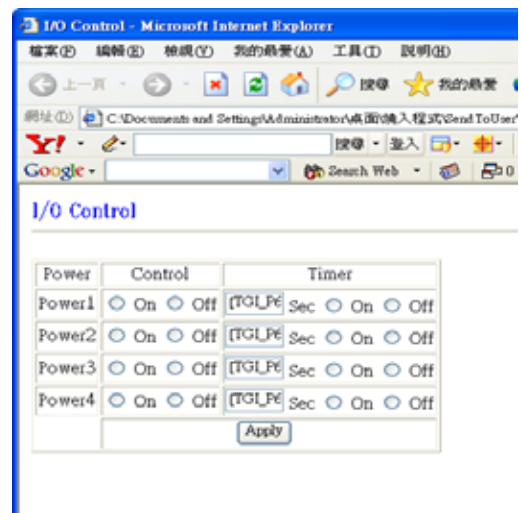

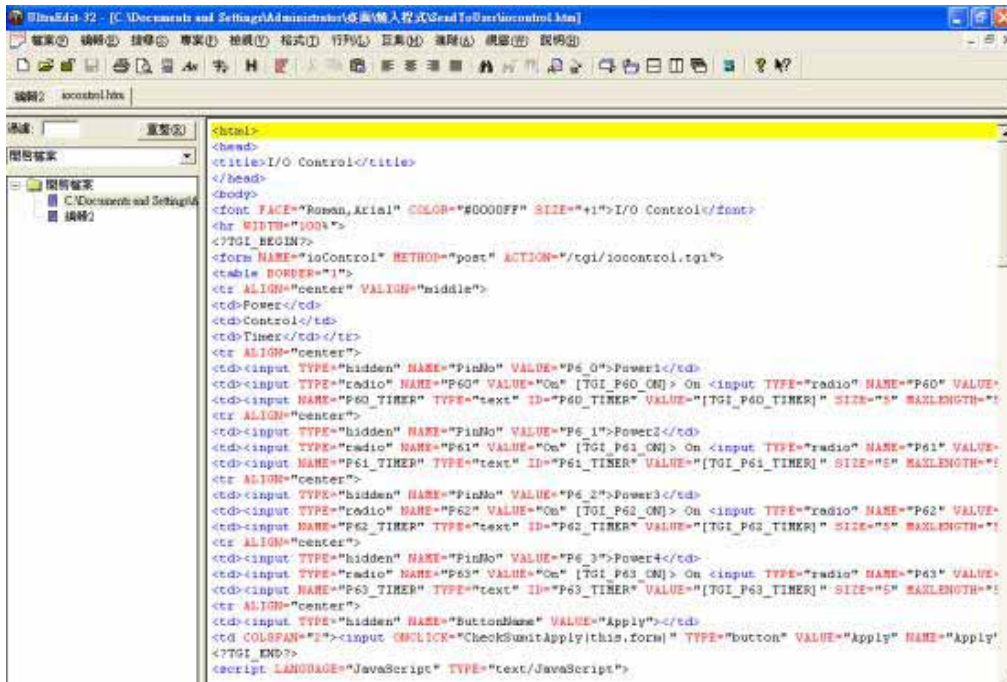

Step 3: Save file format as **"UNIX"**: Choose "DOS to UNIX"



Step 4: Once you are completely done editing the HTML file open the program "Make9258Html" and hit the button "Make Html Patch":

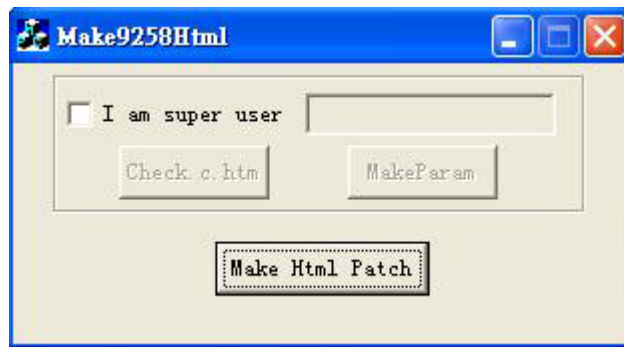

Step 5: There will be a new file “Update_2008-01-11.bin” which is the BIN file include the amend webpage. Please refer to the update procedure to update the firmware BIN file. Please note the Update procedure must be done in **port 80**.

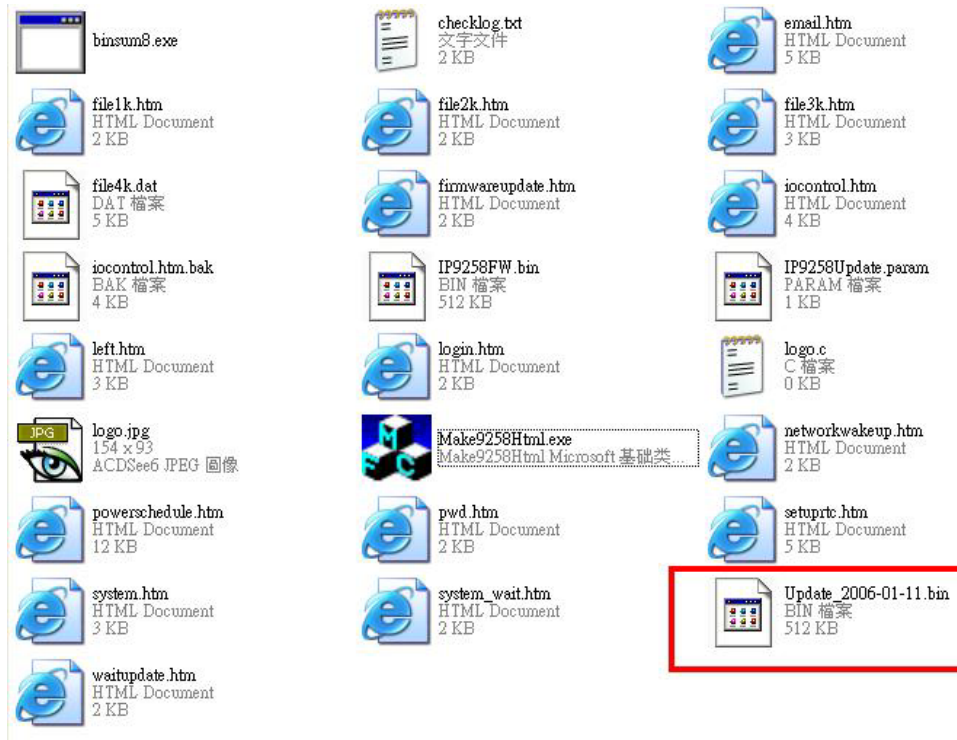

Note: program “Make9258Html.exe “ and amend webpage must in same file.

* **If update fail and can not get IP address by IP EDIT , please use RS232 jack (DB 9 Cable) connect with the PC and 9258, and you can get IP address to log-in and update again. Please refer follow step:**

1. POWER OFF the 9258
2. Use DB9 cable connect to the **COM1** of PC and the RS232 of 9258
3. Execute WIN program "Hyper Terminal" : please go to " Start " --> " program " " Accessories " --> " Communications " → "Hyper Terminal" .



4. Set the "Bits per second" as 19200 at COM1 (Must at COM1)

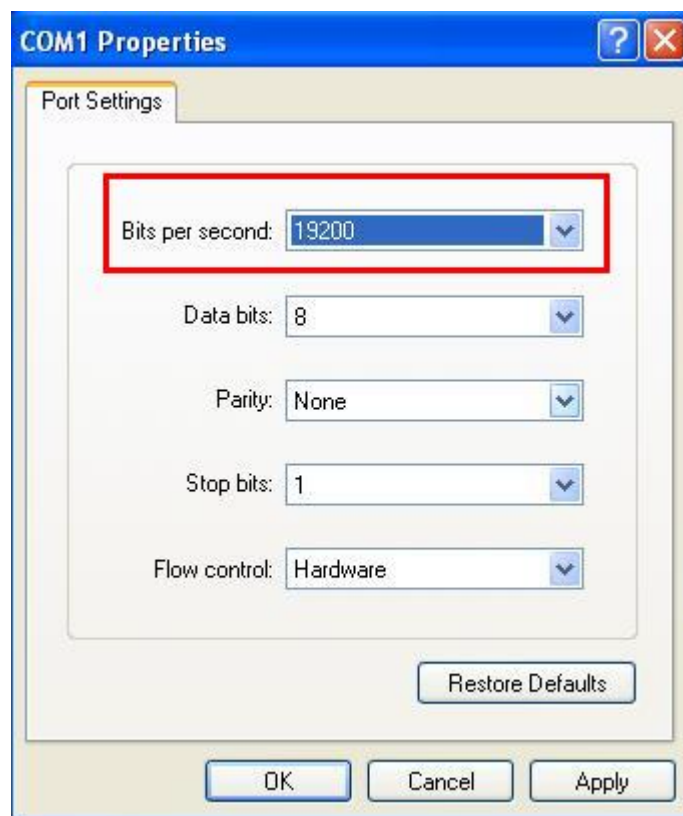

5. After all the settings have been set correctly and the com1 port is plugged into the RS232 of the 9258, Plug in the device and power it up.
6. Once the device is connected look for your IP on the screen where the information is being transferred to. There should be a section that says **MyNowIP**: (Refer to the figure below) XXX.XXX.XXX.XXX If you do not see that information please repeat steps 1-5

```

DHCP Not Enable!!!
config_g gateway ip:c0 a8 64 1
dhcp client not enable
gate c0a8 6401
MyNowIP:192.168.100.104.
config.ipaddr : 192.168.100.104:80
config.gateway : 192.168.100.1
config.dnsserver: 168.95.1
MY_IP : 192.168.100.104
MY_MAC : 00-92-58-00-01-c3
===== TF-33x WebControl SDK V1.30 =====
wapLogin Timeout,IP:0.0.0.0,153

[***LastestUpTime:2006-02-17 08:43:27***]
[****SystemUpTime:2006-02-17 11:26:59***]

```

7. Type this IP Address into Internet Explorer which will let you access the devices web browser
8. Try re-updating the new firmware now.
9. If for some reason you are not successful, please check to see if the bin file is too big. If you need to change the firmware back to original factory default please use the provided bin file V1.22 in the SDK.